

DISOMAT® Opus Weight Indicators



- Legal for trade weighing indicator for a wide variety of applications
- Stainless steel - at a high protection class for table-top and wall mounting
- Top-hat rail design
- Panel installation version
- Built-in legal-for-trade memory (optional)
- Fieldbus interface
- Ethernet interface, can also be used for configuration
- USB cable for optional α/n PC keyboard
- All components can be exchanged without re-verification
- For hazardous areas according to ATEX category 3D

Application

The DISOMAT Opus weighing indicator is perfectly suited to all applications where weights are recorded, displayed and printed legal-for-trade. Results can be transferred to master systems for further processing.

DISOMAT Opus is also excellently suited to simple control jobs in process applications with its complete equipment of interfaces.

This indicator fits easily into data processing and control systems with its extensive communication options, regardless of whether it's PLC or PC.

Some typical applications are:

- Platform scales without major control jobs
- Bin weighers (fill level control and fill or discharge weighing)
- Simple road weigh bridges and crane scales
- Applications as weight transducers for PC-based weighing and data processing systems (such as truck scales)

Equipment

DISOMAT Opus is available in three versions:

- The basic DISOMAT Opus mini VKG 20710 has a serial interface and an analog output
- The expanded DISOMAT Opus maxi design, VKG 20700 also has
 - More serial interfaces
 - Binary I/O
 - A wide range of communication capabilities

Both indicators have a standard stainless steel console shaped case in protection class IP65 that is suited for table-top and wall mounting (cable outlet downward with wall mounting).

These indicators have an easily readable back lighting LCD display for showing weight with clear text operator guidance. Data is keyed in via flexible membrane keyboard with 9 or 21 keys.

Beyond that, there is the

- VEG 20720 design for top-hat rail assembly in the control cabinet – also legal for trade and including a display

- VEG 20700, panel installation unit for installing into a control panel

These instruments also have extensive standard interface equipment that makes it suitable both for control and communication applications.

All instruments – including those with a keyboard – can be conveniently configured and calibrated via the DISOPLAN PC program.

Since Ethernet is increasingly becoming the communication standard even in industry, Opus maxi and the top-hat rail unit have a standard equipment 100 MBaud network connection.

The following options are available

- Legal for trade data memory
- Remote PC keyboard (only with the Opus maxi)
- Fieldbus cards and network cards
- DISOMAT Opus maxi VKG: ATEX category 3D

Communication

With as many as three serial interfaces, DISOMAT Opus is excellently equipped for exchanging data with its environment.

- For example,
- Printer
 - Large display
 - Data processing

can be connected at the same time. Two of the interfaces are designed as RS232. The third (RS485-2/4-wire) is especially suited to communication on the bus and at greater distances.

The Ethernet connector (10/100 MBaud) is operated in the control systems via the Modbus-TCP protocol. Optionally, protocol EtherNet/IP is available as well. Another alternative is calling up HTML pages stored in the instrument via a standard web browser. The instrument can also be configured via the Ethernet connector.

Beyond this fieldbus systems and networks can be connected via optional communication modules.

Parallel signal interchange

For control jobs, DISOMAT Opus has the following parallel inputs and outputs (except Opus mini):

- 4 optocoupler inputs 24 V
- 4 relay outputs, suited for 230 VAC to switch a traffic light

Beyond this, all instruments (including the mini) have a 12 Bit analog output that can transfer weight or material flow to a PLC or display.

Operation and Settings

Standard DISOMAT operation is in German and English. All operator guidance is carried out and data is entered in clear text.

You can easily load other operating languages into the instrument via the PC-assisted DISOPLAN configuration program (WINDOWS program) (Italian, French, Dutch, Polish, Slovakian, Slovenian, Spanish, Czech, Hungarian and Russian are presently available. Other languages are available at request).

DISOPLAN also allows:

- setting all instrument parameters
- calibrating the instrument
- conveniently configuring the print pattern
- read-out and display of weight signals
- reading out the complete instrument configuration (backup)
- restoring stored data into a DISOMAT. This means a substitute can be prepared at short notice

All parameter and calibration data are stored power failure safe in the instrument. The real-time clock runs at least 7 days without a power supply.

Functions

Beyond the basic scale functions such as

- Acquire and clear tare
- Set to zero
- Print

DISOMAT Opus can also carry out a series of other functionalities.

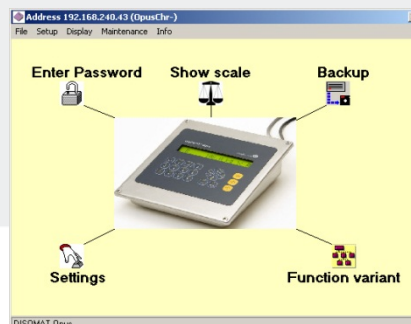

To use them, one of the 'function variants' in the instrument is activated. This puts DISOMAT into a configuration for specific applications that both allocates the essential actions to the six function keys and assigns the inputs and outputs of the instrument to the matching signals.

The following function variants can be activated:

- Cargo scale (weighing/ printing/balancing)
- Filling scale (single component butchering)
- Discharge scale (single component butchering)
- Crane Scale
- Road Weighbridge

Print-out

Variable print pattern formatting allows you to freely lay out your weighing report. You can e. g. print out the following along with the weight data:

- the date and time
- Serial no.
- Balance totals
- the number of balanced weighings
- 5 strings with as many as 25 digits
- 3 stored texts with 26 characters each

You can conveniently format the print-out in the DISOPLAN program. The user arranges all of the printing elements the way they should appear on the print-out later. You no longer have to spend a lot of time keying in control sequences and the like.

Legal-for trade memory

The optional built-in legal-for-trade memory releases the user from the necessity of creating and archiving legal for trade vouchers on paper.

Equipment

In spite of its low price, DISOMAT Opus has enormous processing performance. The 32 Bit ARM controller also has sufficient power reserves for fast weighing processes, simultaneous operation of various interfaces and also for future applications.

Our dongle strategy

Our proven strategy of the intelligent load cell connector (dongle) is also used in DISOMAT Opus: all of the scale's relevant setting and calibration data are stored in the dongle. Since all of our instruments are calibrated at the factory for identical sensitivity, you can interchange the electronic equipment at any time if there is a defect. After attaching the dongle, the scale is correctly configured **and calibrated again**. This means that even legal for trade scales do not have to be recalibrated or reverified.

Pattern approval

DISOMAT Opus is approved for non-automatic scales (throughout the European Union), with a maximum of 6,000 digits or as a multi-range/ multi-interval scale with as many as 3 x 4,000 digits. Together with the maximum resolution of 0.6 μ V / increment, this instrument is well equipped for demanding jobs such as with a high preload.

The dimensioned drawing of DISOMAT Opus VKG mini/maxi

Tabletop mounting

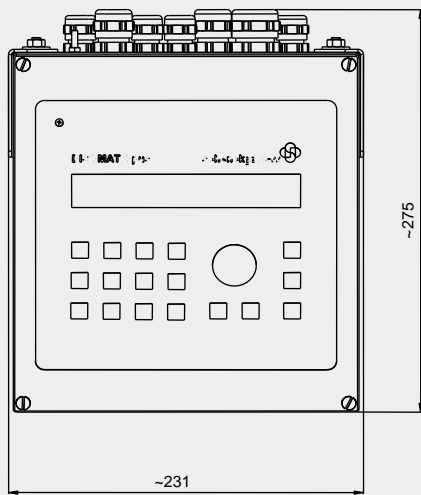

Wall mounting

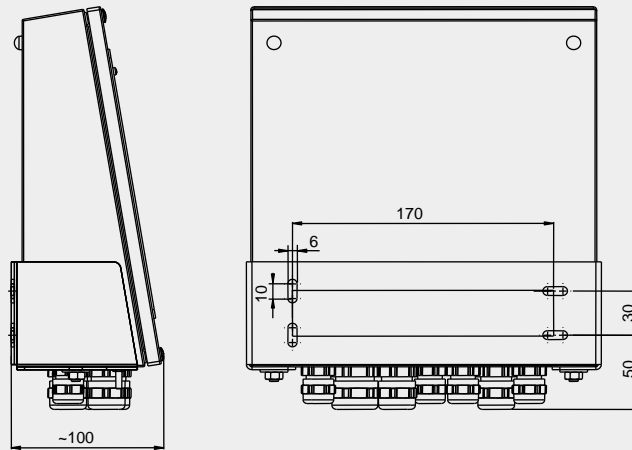

The dimensioned drawing of DISOMAT Opus VEG 20720

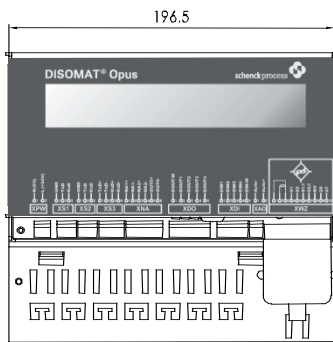
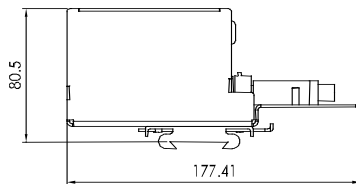
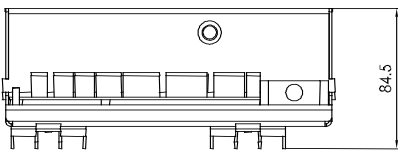

Dimensional drawing
DISOMAT Opus VEG 20700 and
VEG 20750

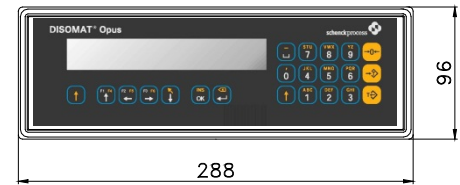

Panel cut-out
282 + 0,5 x 88 + 0,5 [mm]

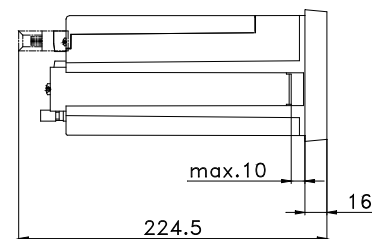

Technical Data

Display	LCD back lighting. 1 row 20 characters. Characters 12 mm high
Keyboard	Flexible membrane keyboard Opus maxi, VKG 20700: 21 keys Opus mini, VKG 20710: 9 keys Opus flush mounting, VEG 20700: 21 keys VEG 20720 top-hat rail module: no keyboard
Supply voltage for VKG/VEG 20700/710 desk-top/wall units	85 ... 250 VAC, 50 ... 60 Hz, max. 10 VA
Supply voltage for VEG 20720 top-hat rail unit	12 ... 36 VDC
Temperature range	Service temperature: -30 °C to +60 °C (legal for trade: -20 °C to +40 °C) Storage temperature: -40 °C to +80 °C
Electro-magnetic environment	E2 (OIML D11)
Measuring channels	1
Load cell supply	5 V alternating current supply
Input signal	0 ... 15 mV
Sensitivity	0.6 μ V / d
Unit	kg, g, t, lb, N, kN
Increment value	1, 2 and 5, etc. adjustable from 0.01 ... 5000
Number of digits	Legal-for-trade operation: max. 6000 d Multi-range scale 3 x 4000 d Multi-interval scale 3 x 4000 d No limitation to resolution in non legal-for-trade operation
Taring	To 100 % of the weighing range
Zero setting device	Can be set max. 20 % Automatic zero tracking 0.5 d/s, can be selected; automatic zero setting can be selected
Linearity error	<0.05 ‰ / 10 K
Zero point stability, TK ₀	<0.6 μ V / 10 K corresponds to 0.04 ‰ / 10 K
Range stability, TK _c	<0.04 ‰ / 10 K
Accuracy, F _{comb}	<0.1 ‰ / 10 K
Load cell impedance	Min. 47 Ω (equalling 8 x 350 Ω load cell or > 20 RT load cells per 4000 Ω)
Date/Time	Real-time clock (RTC), Back-up time at least 7 days
Housing (VKG model)	Stainless steel 1.4301; Protection class IP65, suitable for desk-top and wall mounting
Binary inputs*	4 x optocoupler, 18 ... 36 VDC, type 5 mA
Binary outputs*	4 x relay, 230 VAC, max. 60 W; 1 x optocoupler, 18 ... 36 VDC, max. 100 mA
Analog output	1 x 0(4) ... 20 mA, 12 Bit, max. load 500 Ω

Serial interfaces	3 interfaces for the printer, data processing or secondary display Interface 1: RS232 Interface 2: RS232 * Interface 3: RS485-2/4-wire * max. Baud rate: 38400
Data processing procedures	Siemens 3964R S5 (RK512) Schenck standard procedure DDP8672 Schenck poll procedure DDP8785 Modbus
Secondary display procedures:	DTA DDP8861 DDP8850
Ethernet interface *	10/100 Mbaud, on board, Protocol Modbus-TCP
USB interface *	On board, for PC keyboard
Fieldbus (optional)	PROFIBUS DP-V0 PROFINET IO CC-B DeviceNet EtherNet/IP Modbus-TCP
Other options	PC keyboard (USB) * Legal-for trade memory

* **Only VKG 20700 (Opus maxi) top-hat rail version VEG 20720 and panel installation unit VEG 20700.**

Equipment supplied

V040000.B11	DISOMAT Opus maxi, VKG 20700, Stainless steel unit IP65
V040001.B11	DISOMAT Opus mini, VKG 20710, Stainless steel unit IP65
V040003.B11	DISOMAT Opus maxi, VKG 20740, Stainless steel unit IP65, 24 VDC supply
V040002.B01	DISOMAT Opus top-hat rail unit, VEG 20720
V063320.B01	DISOMAT Opus, Panel installation unit VEG 20700
V063321.B01	DISOMAT Opus, Panel installation unit VEG 20750, 24 VDC supply
V081990.B01	DISOMAT Opus maxi, stainless steel unit for ATEX category 3D, main supply
V095580.B01	DISOMAT Opus maxi, stainless steel unit for ATEX category 3D, 24 VDC supply
V535499.B01	PROFINET kit, VPN 28020 for VKG
V054033.B01	PROFIBUS DP kit, VPB 28020 for VKG
V081906.B01	DeviceNet kit, VCB 28020 for VKG
V081908.B01	PROFIBUS DP kit, VPB 28020 for VEG 20700
V081909.B01	DeviceNet kit, VCB 28020 for VEG 20700
V064721.B06	Procedure EtherNet/IP
V040045.B01	Remote PC keyboard (USB), German key assignment
V040045.B02	Remote PC keyboard (USB), English key assignment
V040026.B01	Legal-for-trade memory VMM 20407

Schenck Process Europe GmbH

Pallaswiesenstr. 100
64293 Darmstadt, Germany
Phone: +49 6151 1531-0
Fax: +49 6151 1531-66
sales@schenckprocess.com
www.schenckprocess.com